

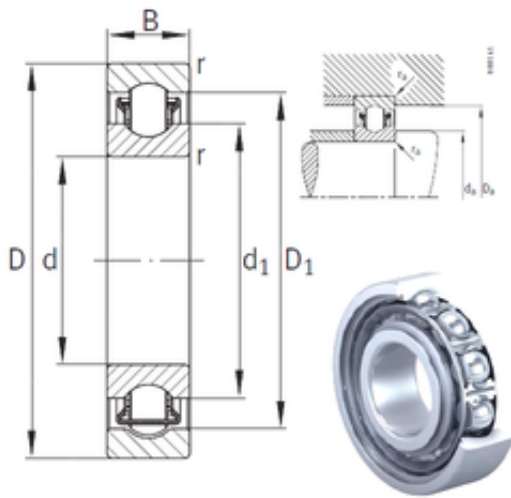

KRS Guide Wheel Bearing Co., Ltd



BXRE006 Bearing 2D drawings and 3D CAD models

30 mm x 55 mm x 13 mm INA BXRE006 needle roller bearings

Bearing No. BXRE006

Size	30x55x13 mm
Bore Diameter	30 mm
Outer Diameter	55 mm
Width	13 mm
d	30 mm
D	55 mm
B	13 mm
C	13 mm
d1	38,9 mm
r min.	1 mm
D1	47,2 mm
da min.	34,6 mm
Da max.	50,4 mm
ra max.	1 mm
Weight	0,124 Kg
Basic dynamic load rating (C)	19,8 kN
Basic static load rating (C0)	15,2 kN
Fatigue load limit (Pu)	770
Reference speed	8 600 r/min